

A

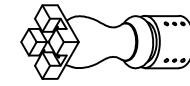

Pillar

1 PC

B

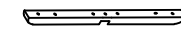

Supporting Bar

2 PCS

C

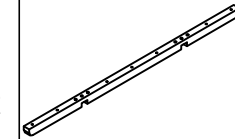

Long Supporting Bar

1 PC

D



Base of Leg

6 PCS

E



Support Rail

1 PC



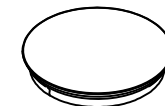



F

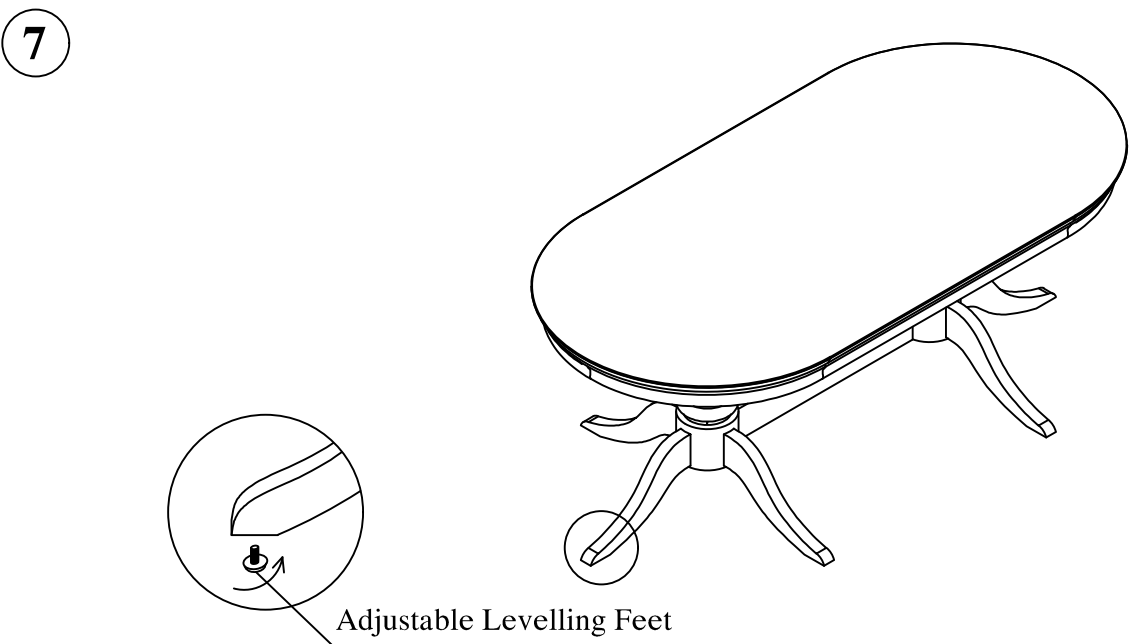
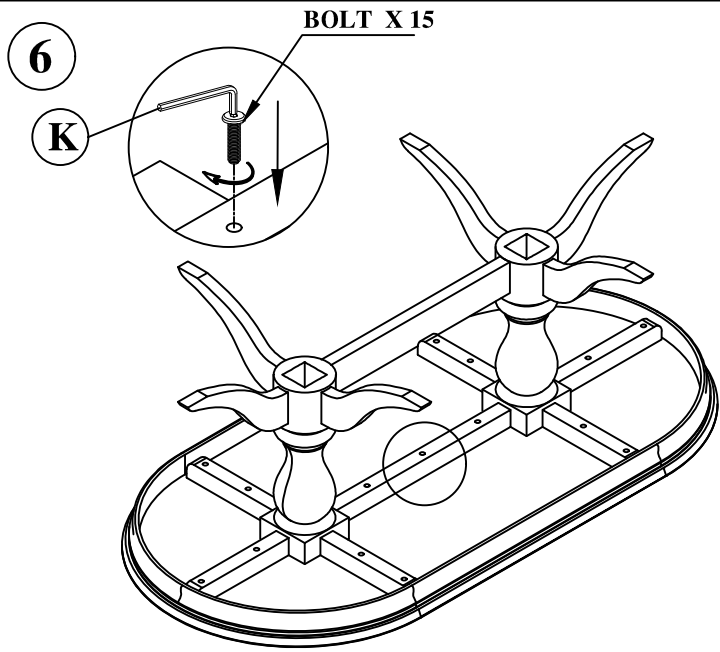
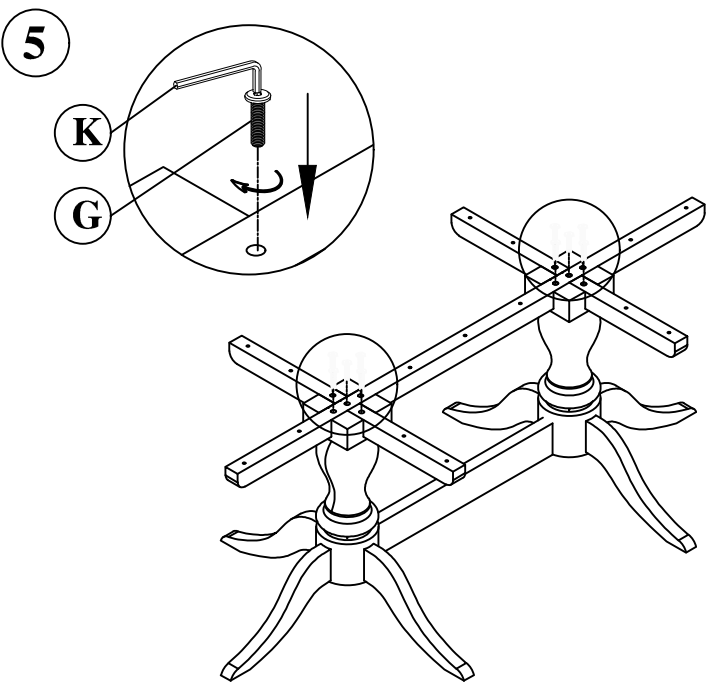

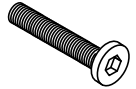
Top Frame

1 PC

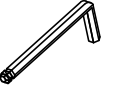

G		Bolts 5/ 16 *65 mm	10 PCS
H		Washer	16 PCS
I		Spring Washer	16 PCS
J		Hex Nut	16 PCS
K		Allen Key	2 PCS
L		Spanner	1PC