

STEP : 1

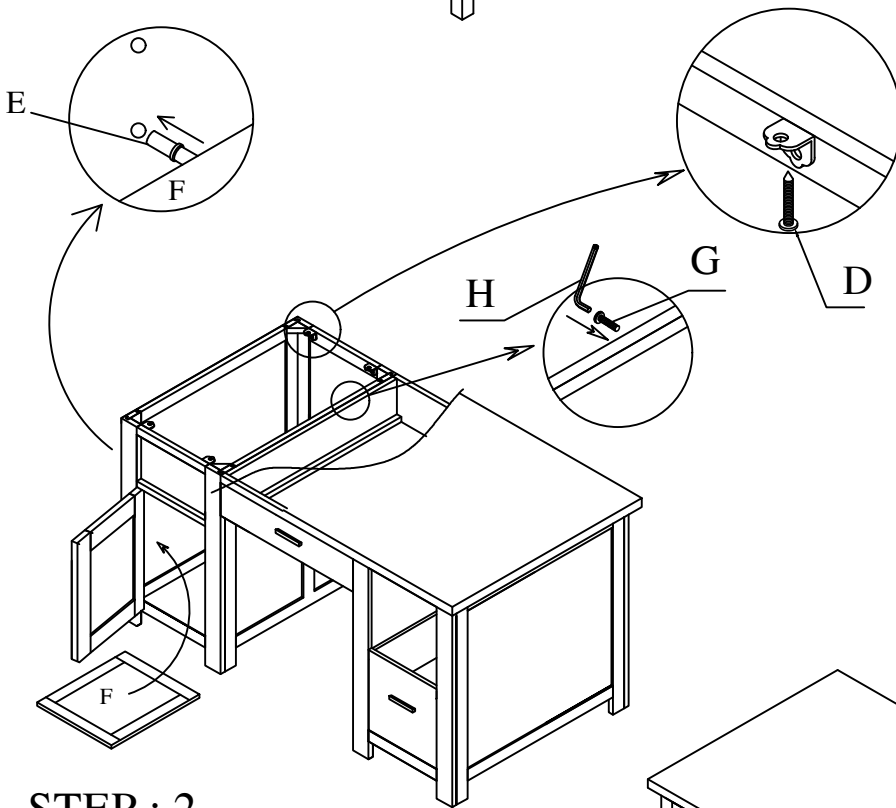

STEP : 2

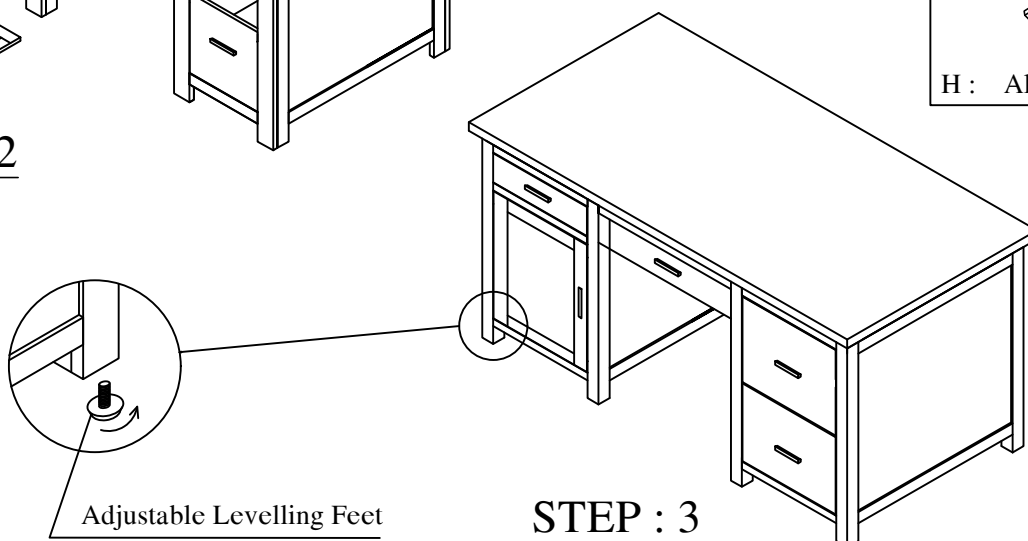

STEP : 3

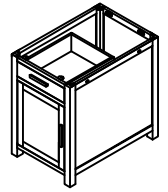

A: LEFT BOX x 01

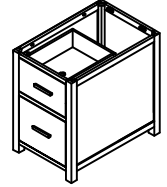

B: RIGHT BOX x 01

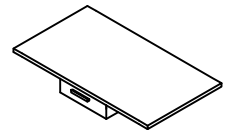

C: TOP x 01



D: Screw 15mm x 08



E: Cotter x 04

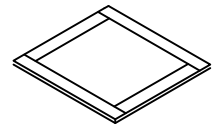

F: Shelf x 01

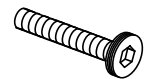

G: Bolts 30mm x 04

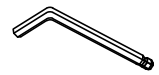

H: Allen Key x 01

Adjustable Levelling Feet