











BAR-70/BAR-71



Ax1  **Gx4** 
Seat Screw
M8x55MM

Bx2  **Hx4** 
Left Right Front legs Screw
M8x60MM

Cx1  **Ix8** 
Front rail Screw
Ø4x45MM

Dx2  **Jx8** 
Left Right Side rails Flat washer

Ex2  **Kx8** 
Left Right Back legs Spring washer

Fx1  **Lx1** 
Back rail Allen key
M6

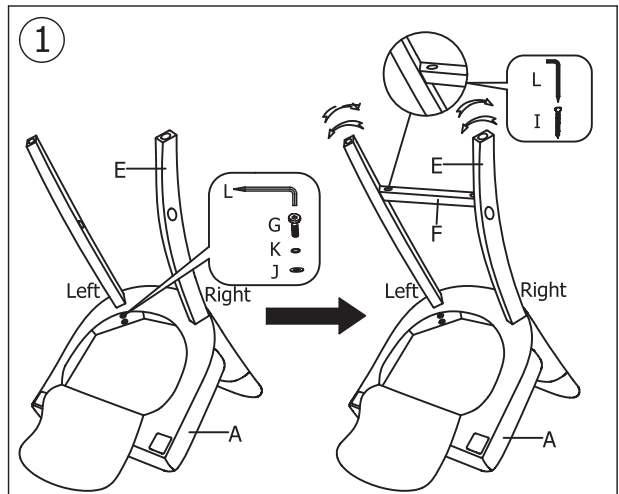

Put the screws in the holes, tighten the screws, but not too tight, 90% is ok.

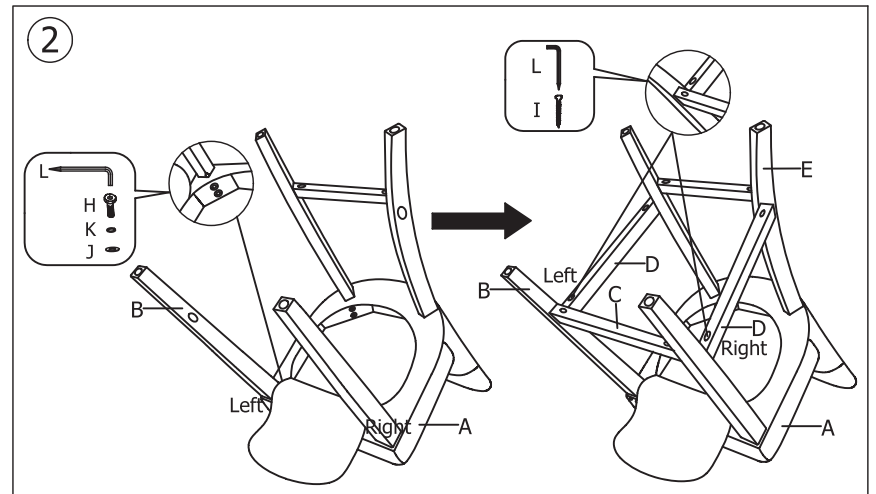

Put the screws in the holes, tighten the screws, but not too tight, 90% is ok.

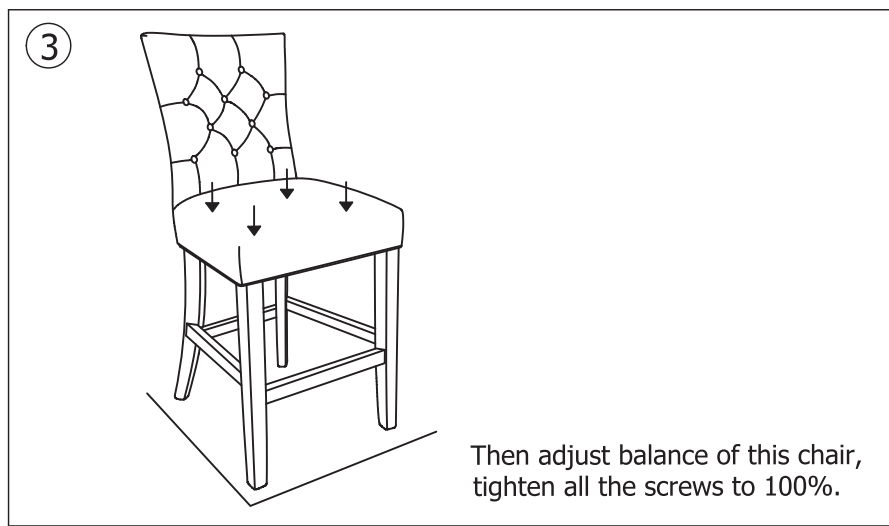

Then adjust balance of this chair, tighten all the screws to 100%.

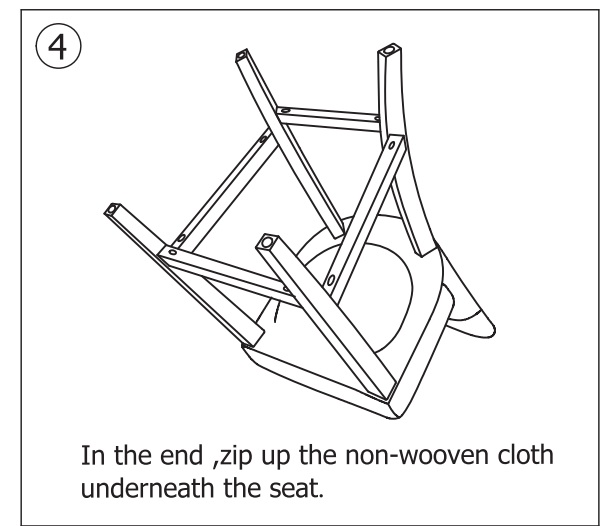

In the end ,zip up the non-woven cloth underneath the seat.

WARNING:
DO NOT STAND ON THE CHAIR, DO NOT USE THIS CHAIR AS A STEP LADDER.
USE THIS PRODUCT ONLY FOR SEATING ONE PERSON AT A TIME.
DO NOT USE THIS CHAIR UNLESS ALL BOLTS, SCREWS AND KNOBS ARE FIRMLY SECURED.
AT LEAST EVERY 4 MONTHS, CHECK ALL BOLTS, SCREWS AND KNOBS TO BE SURE THEY ARE TIGHT.
IF PARTS ARE MISSING, BROKE, DAMAGED OR WORN, STOP USING THIS PRODUCT UNTIL YOU HAVE REPAIRED IT FULLY.
FAILURE TO FOLLOW THESE WARNINGS COULD RESULT IN SERIOUS INJURY.
PLEASE DO NOT USE KNIFE TO OPEN ANY PARTS OF THE BOX OR CHAIR.
CLEANING OF PU/LEATHER COVER - WIPE CLEAN WITH A SOFT CLOTH MOISTENED WITH WATER AND NEUTRAL DETERGENT.
DO NOT USE BLEACH,CHEMICAL OR BIOLOGICAL CLEANERS.