

1200-RND

1.2m Round Table

Assembly instructions

Actual product size

H75xW120xD120cm



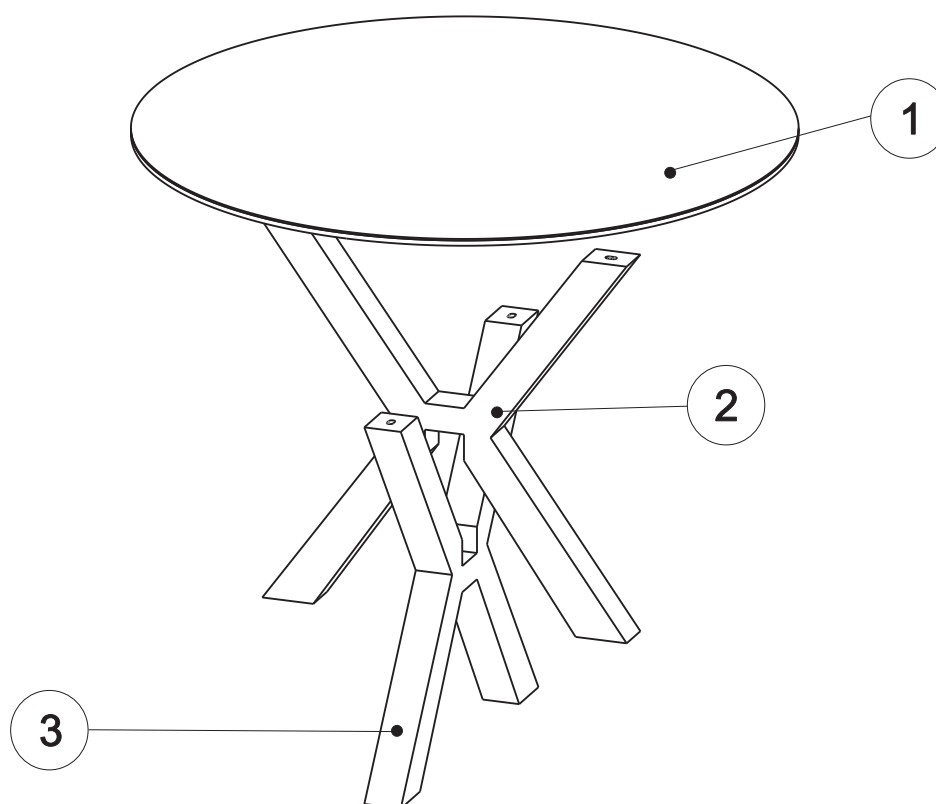

IMPORTANT- RETAIN FOR FUTURE REFERENCE

GETTING TO KNOW YOUR PRODUCT



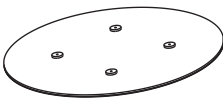
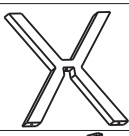

Component supplied

Ref	Dimensions	visual	Qty
1	120x120cm		1
2	71.8x90x7cm		1
3	71.8x90x7cm		1

Fixture and Fittings supplied(actual size)

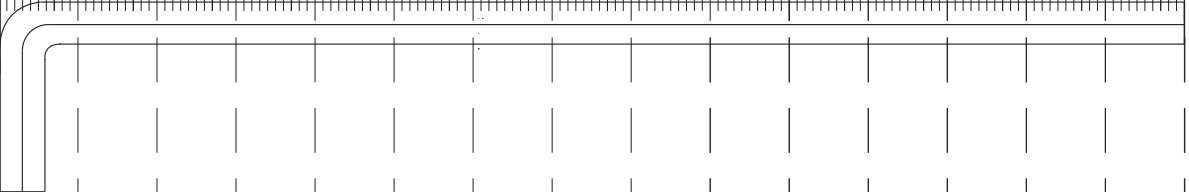
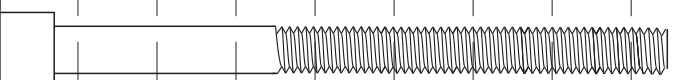
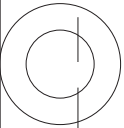
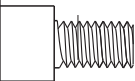
mm 10 20 30 40 50 60 70 80 90 100 110 120 130 140 150 160 170 180

REF	DIMENSIONS	QTY	Spare Part *	
A	150X40MM	1	0	
B	11X86MM	1	0	
C	16X1MM	5	0	
D	11X17MM	4	2	
E	13X2MM	1	0	

* Just to let you know we have included a small quantity of fixings in case of mishap, so don't worry if you've got a few left when you've finished.

Step 1

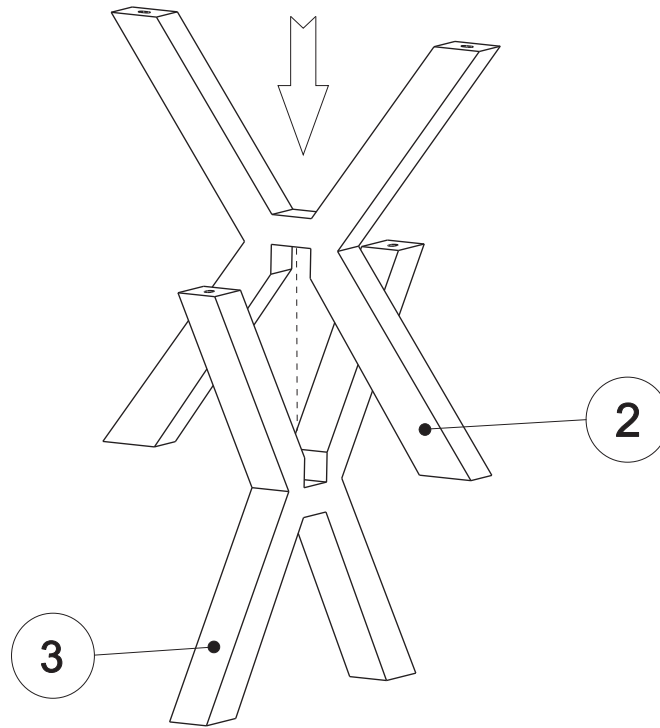

Step 2

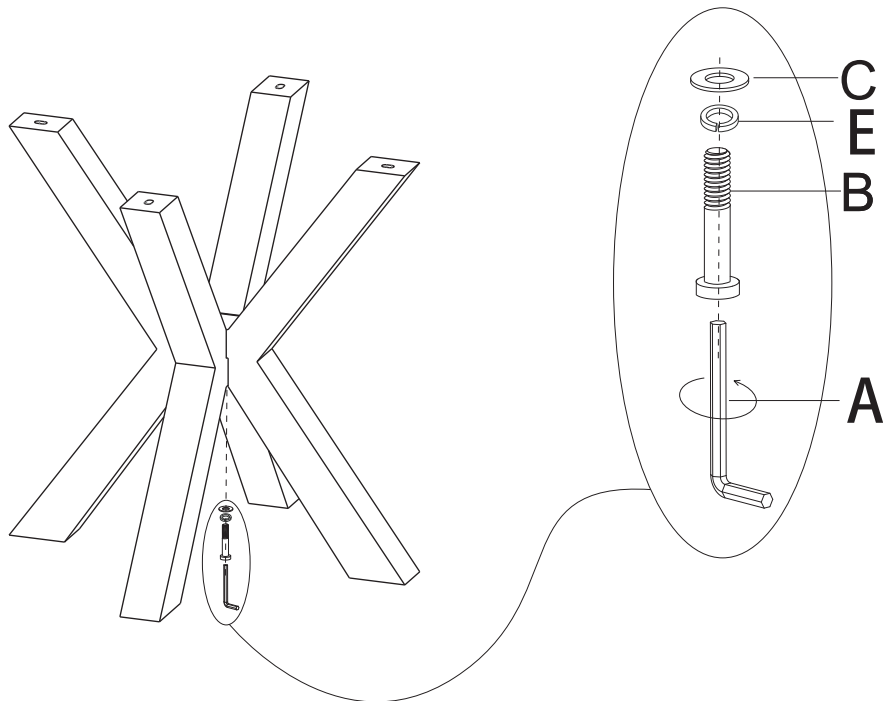

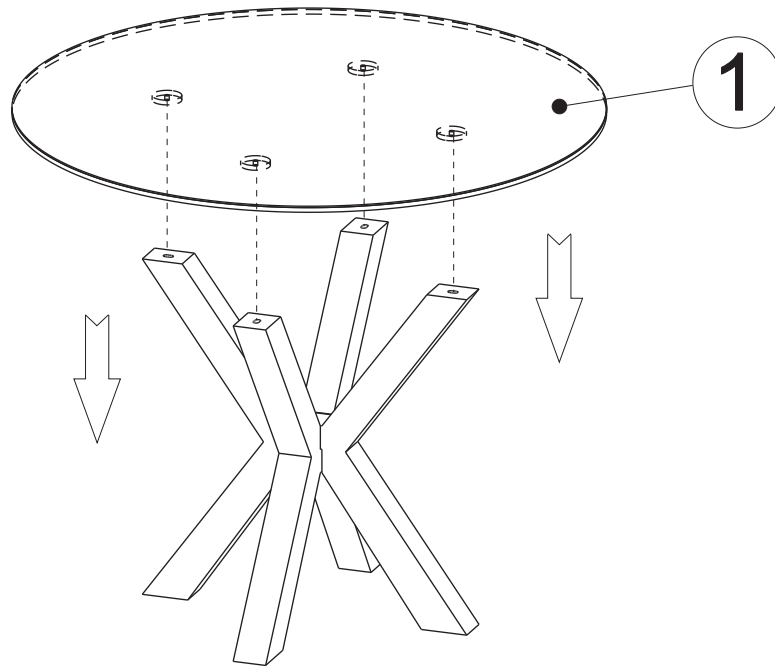

Ax1 150X40MM	Bx1 11X86MM	Cx1 16X1MM	Ex1 13X2MM

Step 3

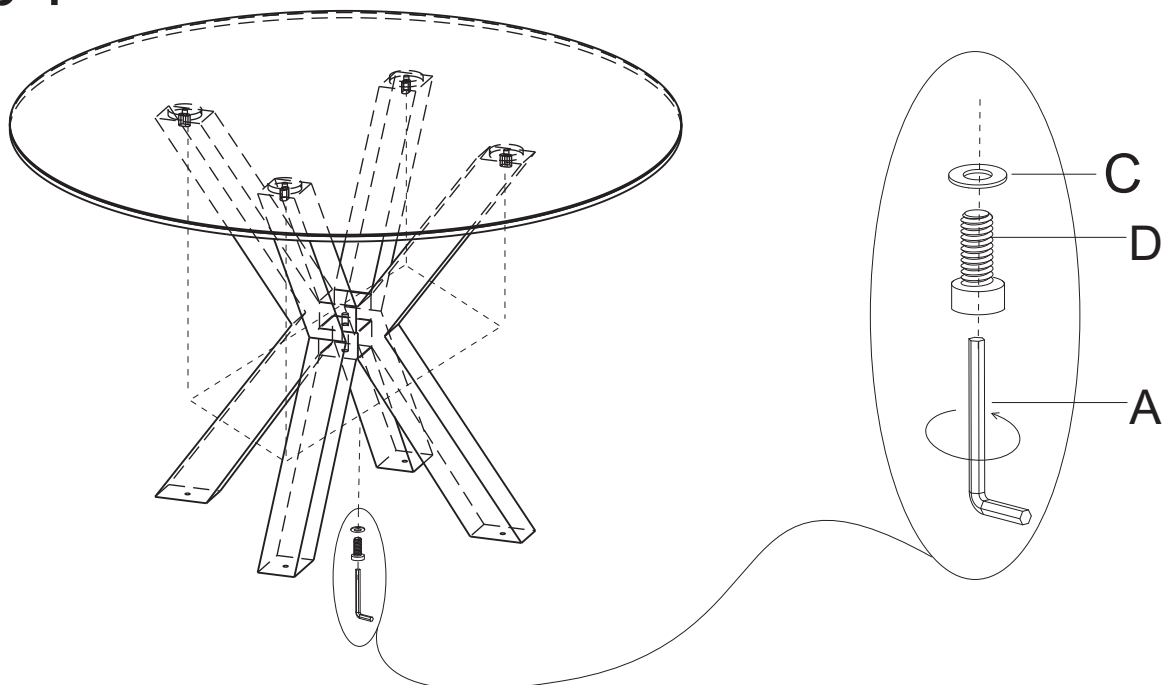

Step 4

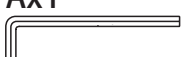

 150X40MM Ax1	 11X17MM Dx4	 16X1MM Cx4
--	---	--

Step 5

The table legs have height adjustable foot pads to allow you to easily level your table on uneven floors. Simply turn the foot pads to adjust the height.

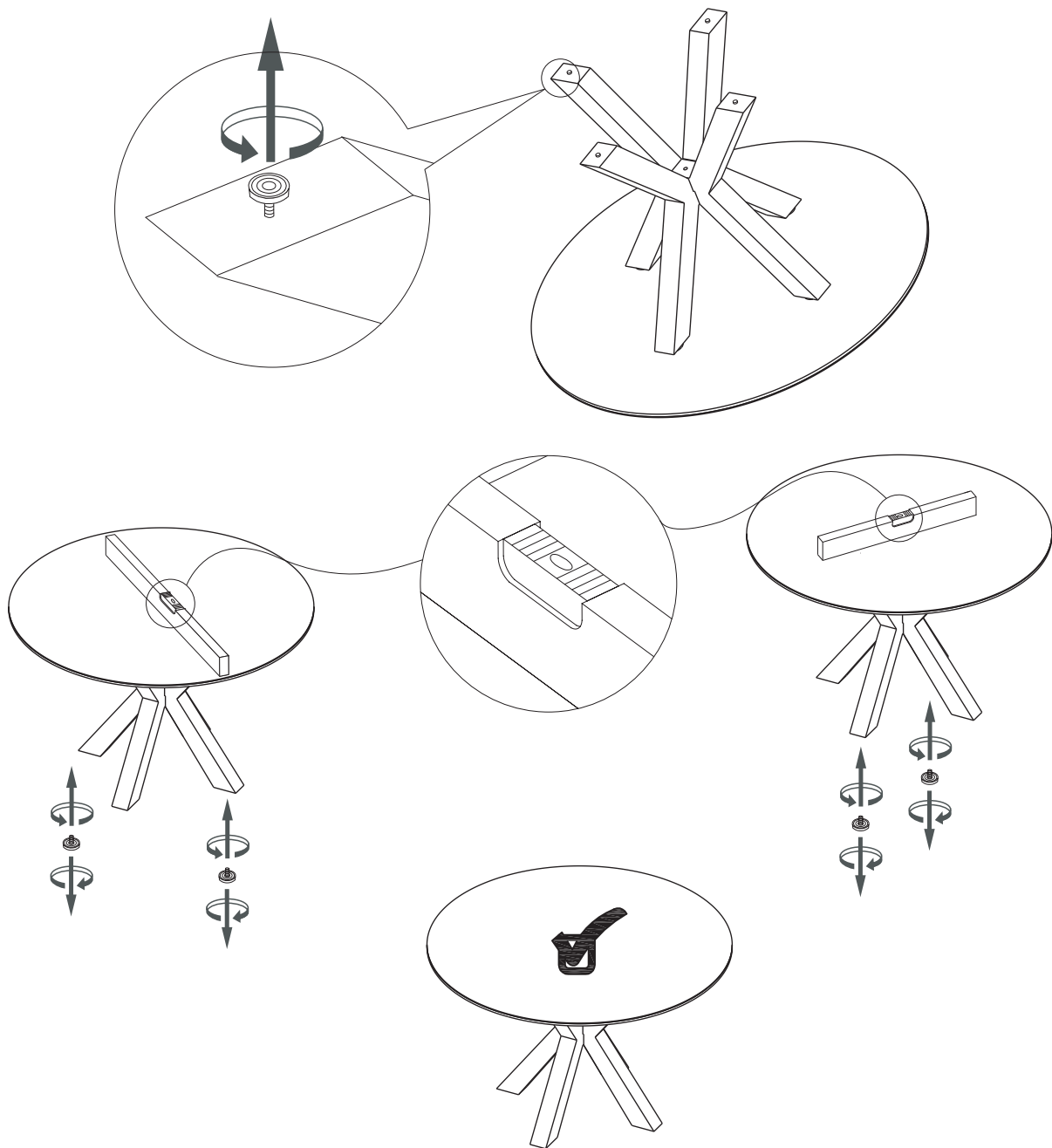

Please note it needs 2 people move or turn over the table carefully.

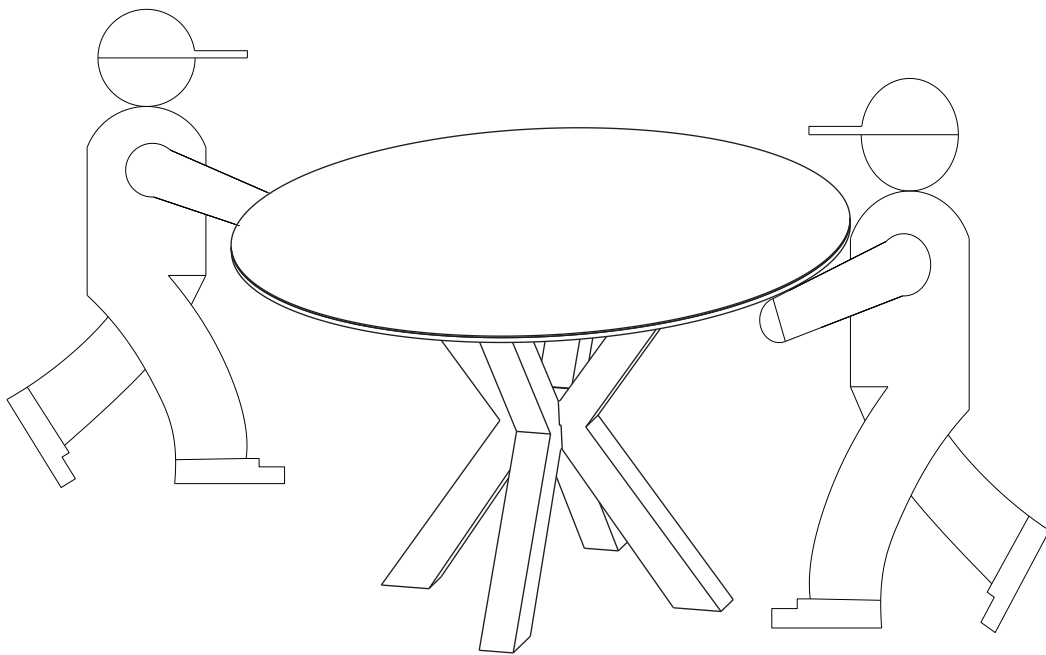

Please note it needs 2 people move or turn over the table carefully.